

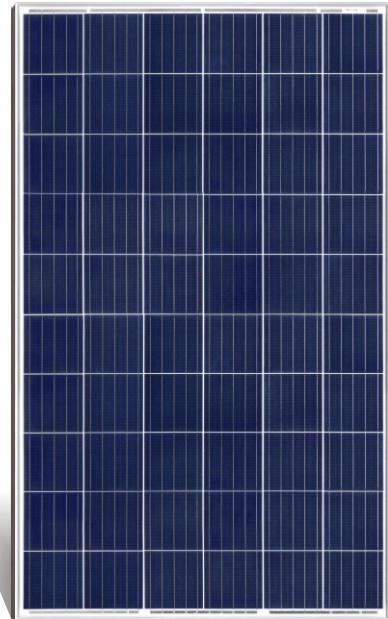







绿色瑞晶 把握未来
Green Risun Grasp future

RSM60-156P

260 – 280W



KEY FEATURES

-  PID resistant
-  Excellent module efficiency
-  Positive power tolerance to +5W
-  100% electroluminescence
-  Heavy snow load 5400 Pa
Wind load 2400 Pa
-  IP67 junction box for long term endurance
-  10 years product warranty
-  25 years linear power warranty

Jiangxi Risun Green Energy Co.,Ltd, is a high-tech PV enterprise dedicated to research & development, production, sales & after sales service, mainly engaged in crystalline silicon solar cells, solar panels, photovoltaic systems, and PV applications. Risun is committed to offer high quality solar components, systems and services to customers around the world.

MANAGEMENT SYSTEMS CERTIFICATES



PRODUCT CERTIFICATES



LINEAR PERFORMANCE WARRANTY

10 year Product Warranty | 25 year Power Output Warranty

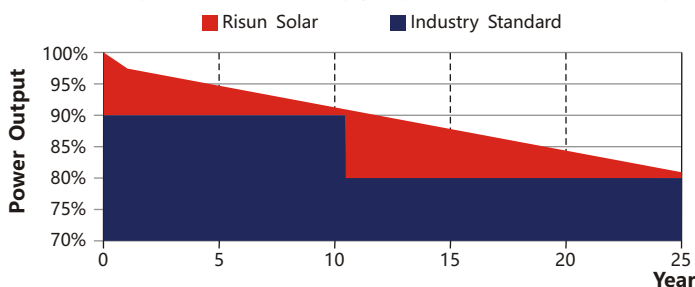

JIANGXI RISUN GREEN ENERGY CO.,LTD.

Add: Dayi Road, Xiacun Industrial Park, Xinyu, Jiangxi, China
Fax: +86 790 6852 888 P.C.: 338019

Web: www.risunsolar.com E-mail: sales@risunsolar.com

International Business Department

Tel: +86 790 685 2825 +86 790 685 2826 +86 790 685 2886

WhatsApp: +86 15907905869 +86 18879015557

Facebook: <https://www.facebook.com/RisunGreenEnergy>



RSM60-156P

260 – 280W

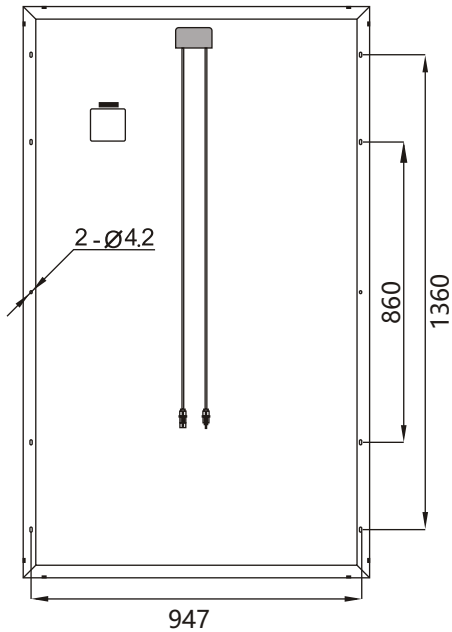

Module Dimension (Unit: mm)

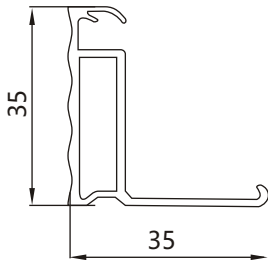

Frame Dimension (Unit: mm)

ELECTRICAL CHARACTERISTICS

	260	265	270	275	280
Maximum Power P_{mp} , [Watt]	260	265	270	275	280
Power Tolerance, [W]	0 / +5				
Voltage at Maximum Power Point V_{mpp} , [V]	30.56	30.81	31.06	31.31	31.56
Current at Maximum Power Point I_{mpp} , [A]	8.51	8.60	8.69	8.78	8.87
Open Circuit Voltage V_{oc} , [V]	37.66	37.91	38.15	38.39	38.63
Short Circuit Current I_{sc} , [A]	9.06	9.13	9.20	9.26	9.32
Module Efficiency, [%]	16.0	16.3	16.6	16.9	17.2

Measurements under Standard Test Conditions (STC)
Irradiance 1000W/m², AM1.5G Spectrum and Cell Temperature 25°C

MECHANICAL CHARACTERISTICS

Cell Type	Poly-crystalline, 156.75mm × 156.75mm
Cell Configuration	60 cells (6 × 10)
Module Dimension	1640mm × 992mm × 35mm
Module Weight	18.2 Kg
Glass	3.2mm, low Iron tempered Solar Glass
Frame	Anodized Al alloy Type 6063 T5; Silver grey
J-Box	Potted, IP67, 1000V/1500V DC, IEC & UL certified
Cable	4.0mm ² / 12 AWG, 1000 mm, IP67
Connectors	QC4.10

THERMAL CHARACTERISTICS

Nominal Operating Temperature NOCT	45 ± 2°C
Temperature Coefficient of I_{sc} , α	+0.049 %/°C
Temperature Coefficient of V_{oc} , β	-0.309 %/°C
Temperature Coefficient of P_{max} , γ	-0.416 %/°C

MAXIMUM OPERATING INSTRUCTIONS

Operating Temperature	-40°C to +85°C
Maximum System Voltage	1000V/1500V
Maximum Series Fuse Rating	15A

PACKING INSTRUCTIONS

Number Of Modules Per Box / Pallet	30
Number of Pallets / 40' Container	28

